

# Scissors

## Vannas Scissors, Super Fine

Length: 8 cm  
Blades: straight 3 mm  
Tips: 0.015 x 0.015 mm

**501778** . . . . . **US\$194**

Tip Profile: 



Length: 8 cm  
Blades: curved 3 mm  
Tips: 0.015 x 0.015 mm

**501839** . . . . . **US\$209**

## Vannas Scissors

Length: 8.5 cm (3.3 in.)  
Blades: straight 7mm  
Tips: 0.025 x 0.015 mm

**500086** . . . . . **US\$183**

Tip Profile: 



Length: 8.5 cm (3.3 in.)  
Blades: curved 7mm  
Tips: 0.025 x 0.015 mm

**501232** . . . . . **US\$190**

## Vannas Scissors

Length: 8 cm (3 in.)  
Blades: straight 5 mm  
Tips: 0.1 mm tips

**14003** . . . . . **US\$132**      **14003-G\*** . . . . . **US\$213**

Tip Profile: 



## Vannas Scissors

Length: 8 cm (3 in.)  
Blades: curved, 5 mm  
Tips: 0.1 mm tips

**14122** . . . . . **US\$137**      **14122-G\*** . . . . . **US\$229**

Tip Profile: 

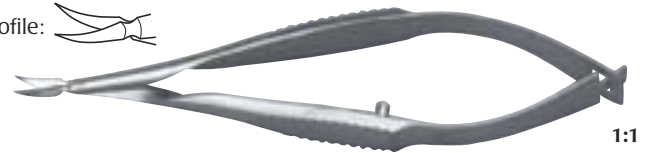

## Vannas Scissors, angled on flat

Length: 8 cm (3 in.)  
Blades: angled, 5 mm  
Tips: 0.1 mm tips

**501790** . . . . . **US\$137**

Tip Profile: 



## Vannas Scissors

Length: 8 cm (3 in.)  
Blades: 45° angled to side, 5 mm  
Tips: 0.1 mm tips

**500260** . . . . . **US\$148**      **500260-G\*** . . . . . **US\$228**

Tip Profile: 

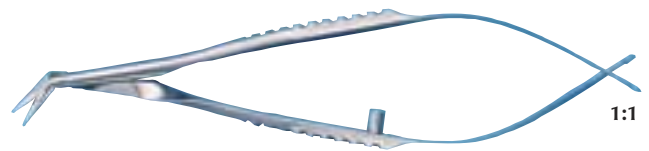

## McPherson-Vannas Scissors

Length: 7 cm (2.75 in.)  
Blades: straight 3 mm  
Tips: 0.1mm

**14177** . . . . . **US\$146**      **14177-G\*** . . . . . **US\$256**

Length: 7 cm (2.75 in.)  
Blades: curved 3 mm  
Tips: 0.1mm

**501233** . . . . . **US\$153**

Tip Profile: 

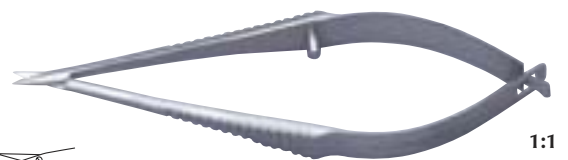

\* Part numbers ending in "-G" indicate German-made instruments

Prices shown are in U.S. dollars. Actual charges will vary because of import duty, freight, and currency fluctuations. To obtain an exact quotation, contact your WPI office.

**McPherson-Vannas Scissors**

Length: 8 cm (3 in.)  
Blades: straight 5 mm  
Tips: 0.1mm

14124 . . . . . US\$132    **14124-G\*** . . . US\$263

Tip Profile: 

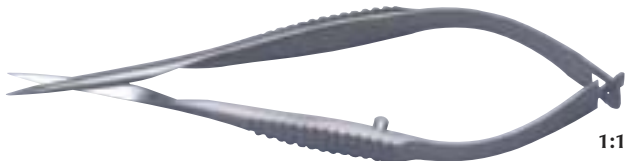

1:1

Length: 8 cm (3 in.)  
Blades: curved 5 mm  
Tips: 0.1mm

501234 . . . . . US\$137    **501234-G\*** US\$268

**Vannas Scissors, Titanium**

Length: 8 cm (3 in.)  
Blades: straight 7.5 mm  
**555640S** . . . US\$230

Tip Profile: 



1:1

**Vannas Scissors, Titanium**

Length: 8 cm (3 in.)  
Blades: angled 7.5 mm  
**555641S** . . . US\$230

Tip Profile:



1:1

**Vannas Scissors, Titanium**

Length: 8 cm (3 in.)  
Blades: straight 3 mm  
**14364** . . . . . US\$230

Tip Profile: 



1:1

**Vannas Scissors, Titanium**

Length: 8 cm (3 in.)  
Blades: angled 3 mm  
**14365** . . . . . US\$230

Tip Profile:



1:1

**Iris scissors Titanium**

Length: 10.5 cm (4 in.)  
Blades: curved  
**555561S** . . . . . US\$216



1:1

**Vannas Scissors, Titanium**

Length: 10.5 cm (4 in.)  
Blades: curved, sharp tips, 12.5 mm  
**555583S** . . . US\$294

Length: 10.5 cm (4 in.)  
Blades: curved, sharp tips, 10.5 mm

**555582S** . . . . . US\$271



1:1

**Vannas scissors Titanium**

Length: 11 cm (4.3 in.)  
Blades: straight, sharp tips, 10.5 mm  
**555580S** . . . . . US\$271



1:1

**Castroviejo Scissors** Titanium

Length: 11 cm (4.3 in.)  
 Blades: cuts 4/0 suture, angled right  
**555521S . . . US\$258**

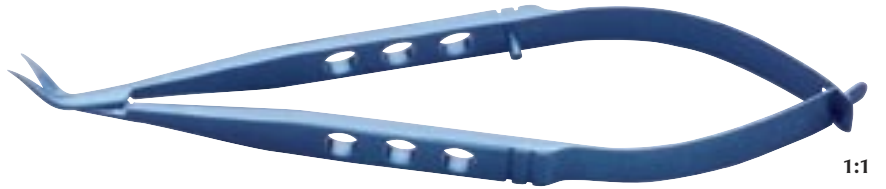

1:1

**Castroviejo Scissors** Titanium

Length: 12 cm (4.75 in.)  
 Blades: strong curve, round handles  
**555523S . . . US\$294**



1:1

**Castroviejo Corneal Scissors** Titanium

Length: 12 cm (4.75 in.)  
 Blades: curved, blunt tips, cuts 6/0 traction suture, round handles  
**555526S . . . US\$271**



1:1

**Vannas Scissors** Titanium

Length: 11 cm (4.3 in.)  
 Blades: straight, 13 mm, sharp points  
**555600S . . . US\$294**



1:1

**Vannas Scissors** Titanium

Length: 10.5 cm (4 in.)  
 Blades: angled, sharp tips, 10.5 mm  
**555584S . . . US\$271**



1:1

**McPherson-Westcott Stitch Scissors** Titanium

Length: 11.5 cm (4.5 in.)  
 Blades: very sharp pointed tips  
**555540S . . . US\$244**

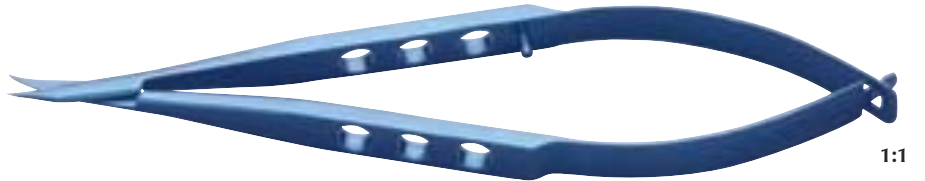

1:1

**Westcott Stitch Scissors** Titanium

Length: 11 cm (4.3 in.)  
 Blades: very sharp pointed tips  
**555541S . . . US\$244**



1:1

**McPherson-Westcott scissors** Titanium

Length: 11 cm (4.3 in.)  
 Blades: curved blunt tips, cuts 4-0 suture  
**555500S . . . US\$212**



1:1

Prices shown are in U.S. dollars. Actual charges will vary because of import duty, freight, and currency fluctuations. To obtain an exact quotation, contact your WPI office.

**Westcott Tenotomy Scissors** Titanium

Length: 11.5 cm (4.5 in.)  
Blades: curved blunt tips

**555620S** . . . **US\$244**



1:1

**Conjunctival Scissors** Titanium

Length: 12 cm (4.75 in.)  
Blades: curved, blunt tips

**555501S** . . . **US\$258**



1:1

**Spring Scissors**

Length: 10.5 cm (4 in.)  
Blades: straight 8 mm

**501235** . . . . . **US\$102**

Length: 10.5 cm (4 in.)  
Blades: curved 8 mm

**14127** . . . . . **US\$102**    **14127-G\*** . . . **US\$252**

Tip Profile:



1:1

**Spring Scissors**

Length: 12 cm (4.75 in.)  
Blades: straight 12 mm extra fine and long

**14125** . . . . . **US\$148**

Length: 12 cm (4.75 in.)  
Blades: curved 12 mm extra fine and long

**14126** . . . . . **US\$148**

Tip Profile:



1:1

**Noyes Scissors, sharp/sharp tips**

**500228** 12 cm long, straight 15 mm blades . . . **US\$49**  
**501236** 12 cm long, curved 15 mm blades . . . **US\$49**

**500228-G\*** . . . **US\$229**  
**501236-G\*** . . . **US\$207**

**501237** 14 cm long, straight 20 mm blades . . . **US\$49**  
**501238** 14 cm long, curved 20 mm blades . . . **US\$49**



1:1

**Spring Scissors, round handles**

Length: 14 cm (5.5 in.)  
Blades: straight 6.5 mm

**14111** . . . . . **US\$91**  
**14111-G\*** . . . **US\$357**

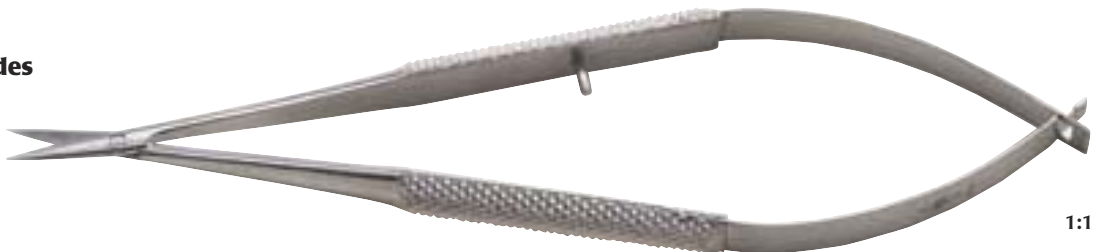

1:1

**Spring Scissors, round handles**

Length: 14 cm (5.5 in.)  
Blades: curved 7 mm

**14112** . . . . . **US\$91**  
**14112-G\*** . . . **US\$361**

Tip Profile:

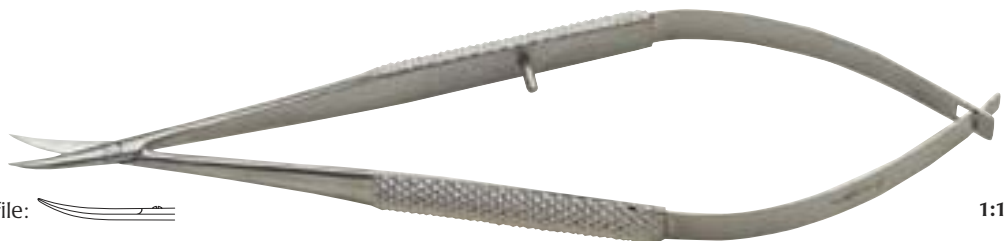

1:1

**Spring Scissors**

Length: 14 cm (5.5 in.)  
Blades: straight 8 mm

**15905** . . . . . **US\$60**  
**15905-G\*** . . . . . **US\$276**

Length: 14 cm (5.5 in.)  
Blades: curved 8 mm

**15906** . . . . . **US\$60**  
**15906-G\*** . . . . . **US\$276**

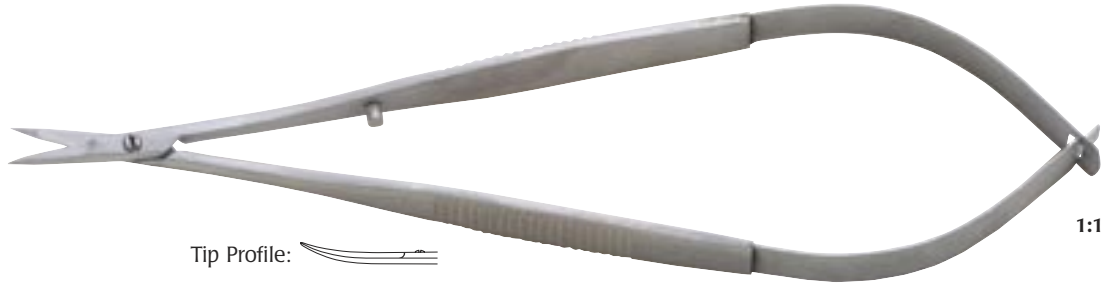

**Dissecting Scissors**

**14393** 10 cm (4 in.) straight . . . **US\$17**  
**14394** 10 cm (4 in.) curved . . . **US\$17**  
**15922** 12.5 cm (5 in.) straight . . **US\$17**  
**15923** 12.5 cm (5 in.) curved . . **US\$17**

**14393-G\*** . . . . . **US\$40**  
**14394-G\*** . . . . . **US\$41**  
**15922-G\*** . . . . . **US\$35**  
**15923-G\*** . . . . . **US\$35**

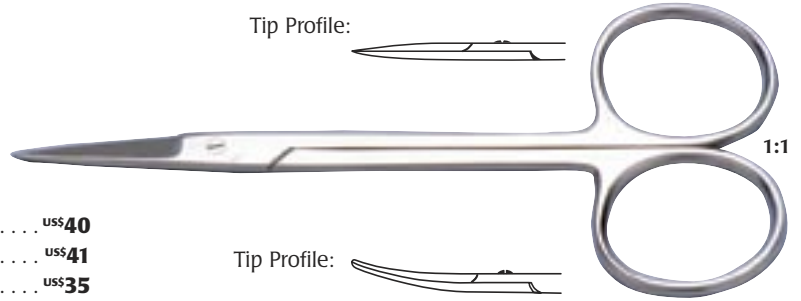

**Iris Scissors**

Length: 11 cm (4.3 in.)  
Blades: straight

**501758** . . . . . **US\$22**      **501758-G\*** . . . . . **US\$45**

Length: 11 cm (4.3 in.)  
Blades: curved

**501759** . . . . . **US\$22**      **501759-G\*** . . . . . **US\$45**

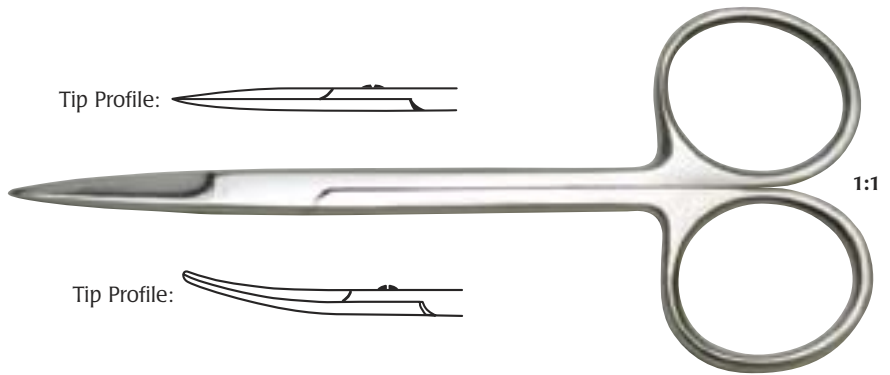

**Iris Scissors**

Length: 11 cm (4.3 in.)  
Blades: straight **Tungsten Carbide**

**500216** . . . . . **US\$51**      **500216-G\*** . . . . . **US\$102**

Length: 11 cm (4.3 in.)  
Blades: curved **Tungsten Carbide**

**500217** . . . . . **US\$51**      **500217-G\*** . . . . . **US\$102**

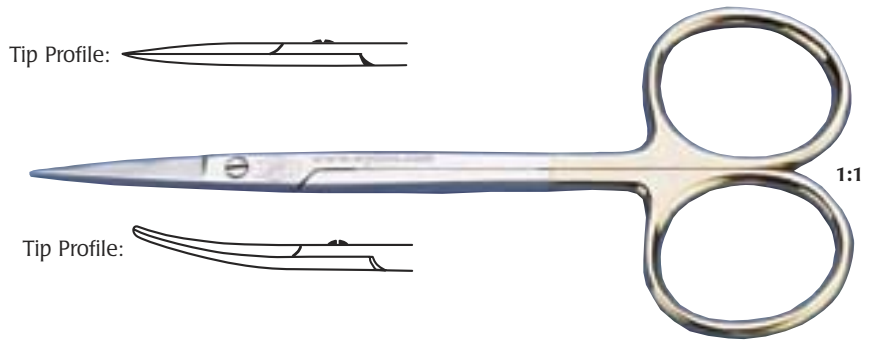

**Utility Eye Scissors** **Titanium**

Length: 11 cm (4.3 in.)  
Blades: straight, standard pointed tips

**555646S** . . . . . **US\$221**



\* Part numbers ending in "-G" indicate German-made instruments

**Titanium** instruments MRI compatible

Prices shown are in U.S. dollars. Actual charges will vary because of import duty, freight, and currency fluctuations. To obtain an exact quotation, contact your WPI office.

**Iris Scissors, SuperCut 10 cm (4 in.)**

- Straight    **14218** ..... <sup>US\$</sup>51
- 14218-G\*** ..... <sup>US\$</sup>75
- Curved     **14219** ..... <sup>US\$</sup>51
- 14219-G\*** ..... <sup>US\$</sup>75

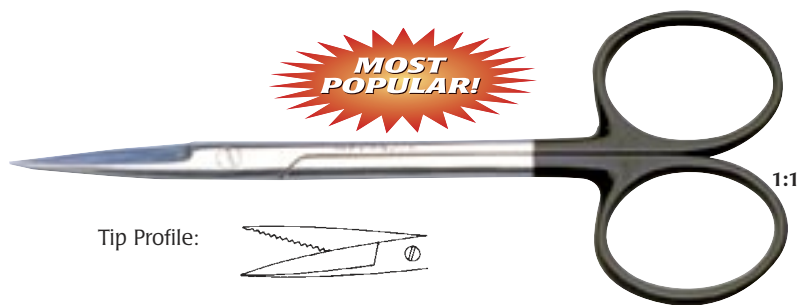

**Iris Scissors, SuperCut 12.5 cm (5 in.)**

- Straight    **14225** ..... <sup>US\$</sup>51
- 14225-G\*** ..... <sup>US\$</sup>75
- Curved     **14224** ..... <sup>US\$</sup>51
- 14224-G\*** ..... <sup>US\$</sup>75

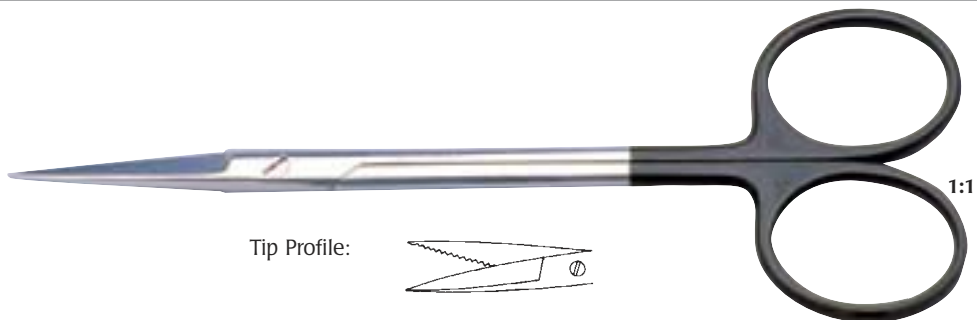

**SuperCut Tungsten Carbide Iris Scissors**

These are the finest scissors available. They combine the precise cutting action of the razor-sharp SuperCut blades with the durability of **Tungsten Carbide**. They will provide a clean, smooth cut and retain their sharpness for an extended period of time.

- 501263-G\*** Iris, straight, 11 cm (4.3 in.) long ... <sup>US\$</sup>194
- 501264-G\*** Iris, curved, 11 cm (4.3 in.) long. .... <sup>US\$</sup>197

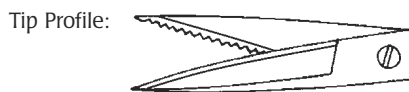
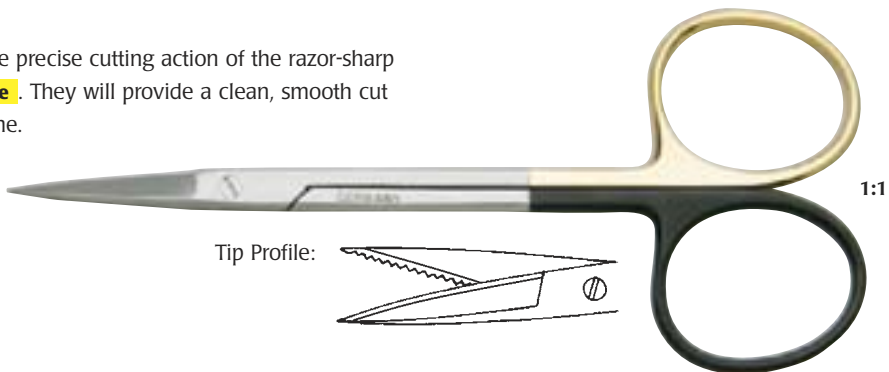

**Ribbon Handle Iris Scissors**

*Larger ring handles for ease of use*

- 501767**     Iris, straight, 11 cm (4.3 in.) long ..... <sup>US\$</sup>45
- 501768**     Iris, curved, 11 cm (4.3 in.) long. .... <sup>US\$</sup>45

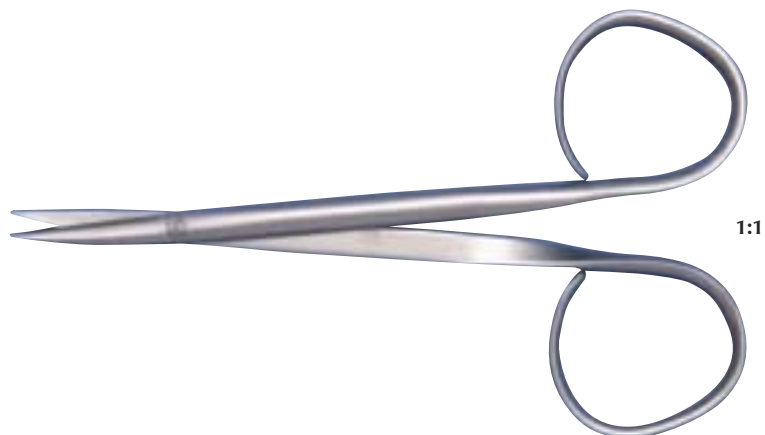

**Tenotomy Scissors, SuperCut 10 cm (4 in.)**

- Straight, sharp tips
- 14395** ..... <sup>US\$</sup>51
- 14395-G\*** ..... <sup>US\$</sup>75
- Curved, sharp tips
- 14396** ..... <sup>US\$</sup>51
- 14396-G\*** ..... <sup>US\$</sup>75

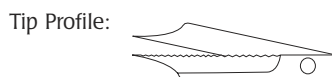

\* Part numbers ending in "-G" indicate German-made instruments

Prices shown are in U.S. dollars. Actual charges will vary because of import duty, freight, and currency fluctuations. To obtain an exact quotation, contact your WPI office.

World Precision Instruments • Tel: 941-371-1003 • Fax: 941-377-5428 • E-mail: sales@wpiinc.com • Internet: www.wpiinc.com

**Tenotomy Scissors, SuperCut 12.5 cm (5 in.)**

Straight, sharp tips **14220** . . . . . **US\$51**  
**14220-G\*** . . . . . **US\$75**

Curved, sharp tips **14221** . . . . . **US\$51**  
**14221-G\*** . . . . . **US\$75**

Tip Profile:

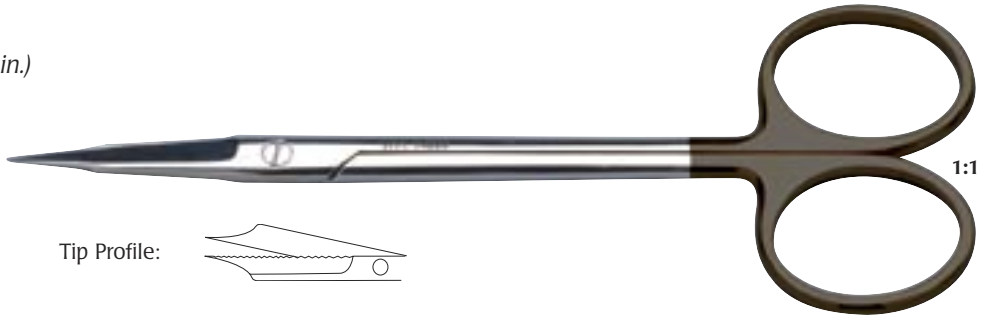
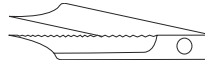

**Metzenbaum Scissors**

**501747** 11.5 cm (4.5 in.) straight . . . . . **US\$17**    **501747-G\*** . . . . . **US\$37**

**501748** 11.5 cm (4.5 in.) curved . . . . . **US\$17**    **501748-G\*** . . . . . **US\$37**

**501252** 14.5 cm (5.75 in.) straight (shown) . . . . . **US\$17**    **501252-G\*** . . . . . **US\$37**

**501253** 14.5 cm (5.75 in.) curved . . . . . **US\$17**    **501253-G\*** . . . . . **US\$37**

**501254** 17.5 cm (7 in.) straight . . . . . **US\$18**    **501254-G\*** . . . . . **US\$40**

**501255** 17.5 cm (7 in.) curved . . . . . **US\$18**    **501255-G\*** . . . . . **US\$40**



**Metzenbaum Scissors, Carbide Blades**

**501739** 11.5 cm (4.5 in.), straight blades . . . . . **US\$58**    **501739-G\*** . . . . . **US\$114**

**501740** 11.5 cm (4.5 in.), curved blades . . . . . **US\$58**    **501740-G\*** . . . . . **US\$114**

**501733** 14.5 cm (5.75 in.), straight blades . . . . . **US\$58**    **501733-G\*** . . . . . **US\$114**

**501734** 14.5 cm (5.75 in.), curved blades . . . . . **US\$60**    **501734-G\*** . . . . . **US\$114**

**501744** 18 cm (7 in.), straight blades . . . . . **US\$62**    **501744-G\*** . . . . . **US\$114**

**501745** 18 cm (7 in.), curved blades . . . . . **US\$62**    **501745-G\*** . . . . . **US\$114**

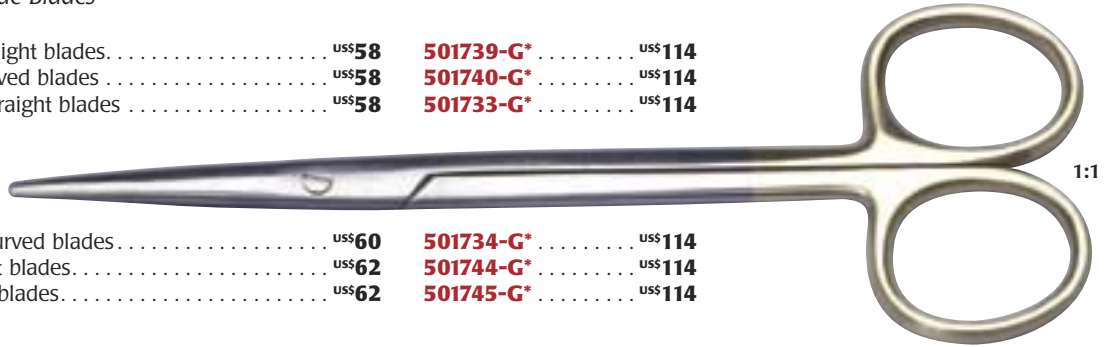

**Metzenbaum Scissors, SuperCut 12.5 cm (5 in.)**

Straight **14214** . . . . . **US\$51**  
**14214-G\*** . . . . . **US\$75**

Curved **14215** . . . . . **US\$51**  
**14215-G\*** . . . . . **US\$75**

Tip Profile:

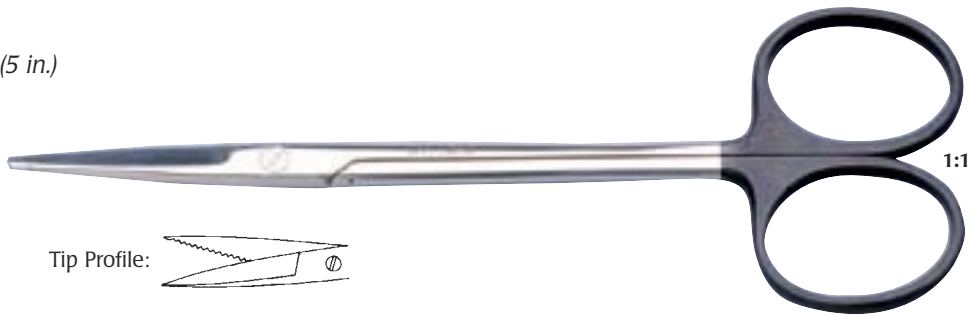
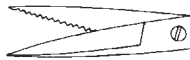

**SuperCut Tungsten Carbide Metzenbaum Scissors**

These are the finest scissors available. They combine the precise cutting action of the razor-sharp SuperCut blades with the durability of **Tungsten Carbide**. They will provide a clean, smooth cut and retain their sharpness for an extended period of time.

**501261-G\*** Metzenbaum, curved, 15 cm long . . . . . **US\$198**

**501262-G\*** Metzenbaum, curved, 18 cm long . . . . . **US\$199**

Tip Profile:

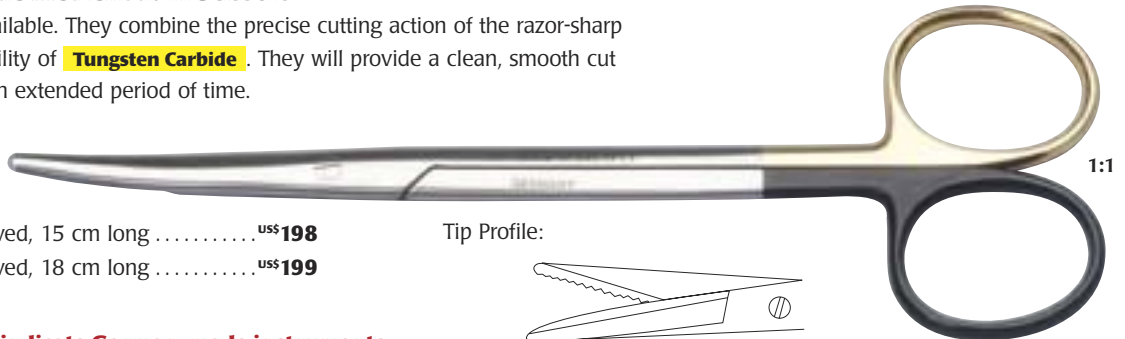
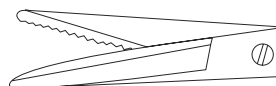

\* Part numbers ending in "-G" indicate German-made instruments

Prices shown are in U.S. dollars. Actual charges will vary because of import duty, freight, and currency fluctuations. To obtain an exact quotation, contact your WPI office.

**Mayo Scissors**

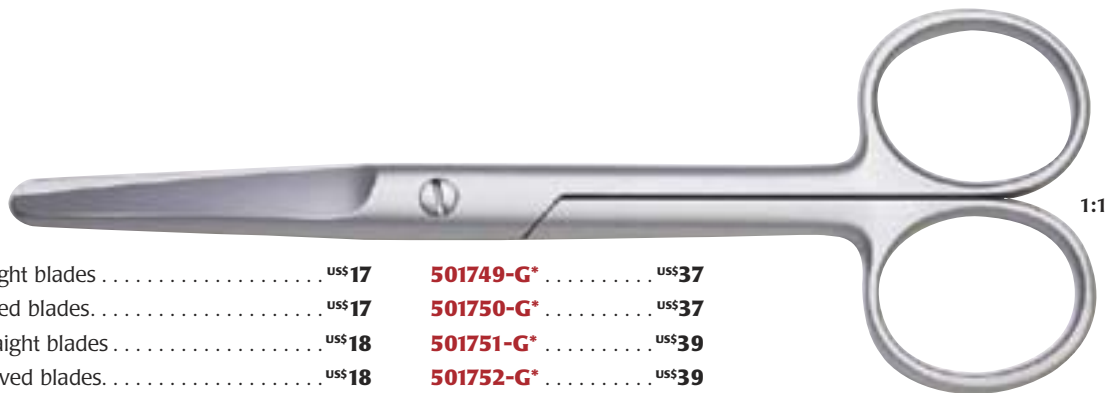

<b>501749</b>	14 cm (5.5 in.), straight blades	US\$17	<b>501749-G*</b>	US\$37
<b>501750</b>	14 cm (5.5 in.), curved blades	US\$17	<b>501750-G*</b>	US\$37
<b>501751</b>	17 cm (6.75 in.), straight blades	US\$18	<b>501751-G*</b>	US\$39
<b>501752</b>	17 cm (6.75 in.), curved blades	US\$18	<b>501752-G*</b>	US\$39

**Mayo Scissors, Carbide Blades**

Tip Profile:

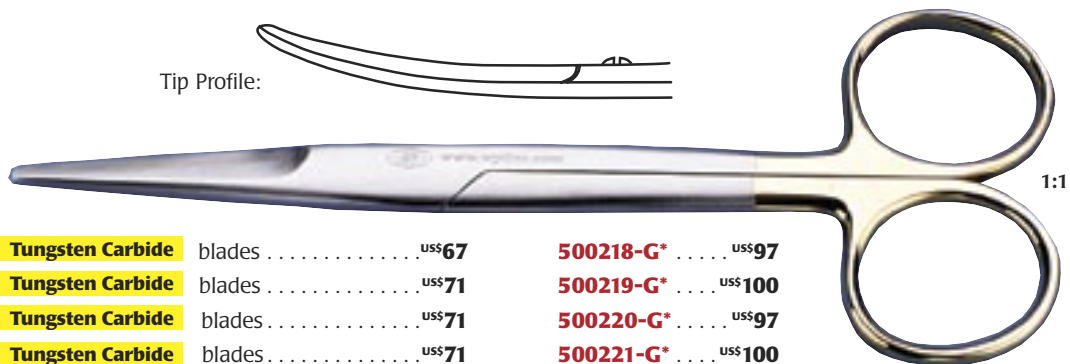

<b>500218</b>	14 cm (5.5 in.), straight	<b>Tungsten Carbide</b> blades	US\$67	<b>500218-G*</b>	US\$97
<b>500219</b>	14 cm (5.5 in.), curved	<b>Tungsten Carbide</b> blades	US\$71	<b>500219-G*</b>	US\$100
<b>500220</b>	17.5 cm (7 in.), straight	<b>Tungsten Carbide</b> blades	US\$71	<b>500220-G*</b>	US\$97
<b>500221</b>	17.5 cm (7 in.), curved	<b>Tungsten Carbide</b> blades	US\$71	<b>500221-G*</b>	US\$100

**Mayo Scissors, SuperCut 14 cm (5.5 in.)**

Straight	<b>14216</b>	US\$48
	<b>14216-G*</b>	US\$83
Curved	<b>14217</b>	US\$48
	<b>14217-G*</b>	US\$83

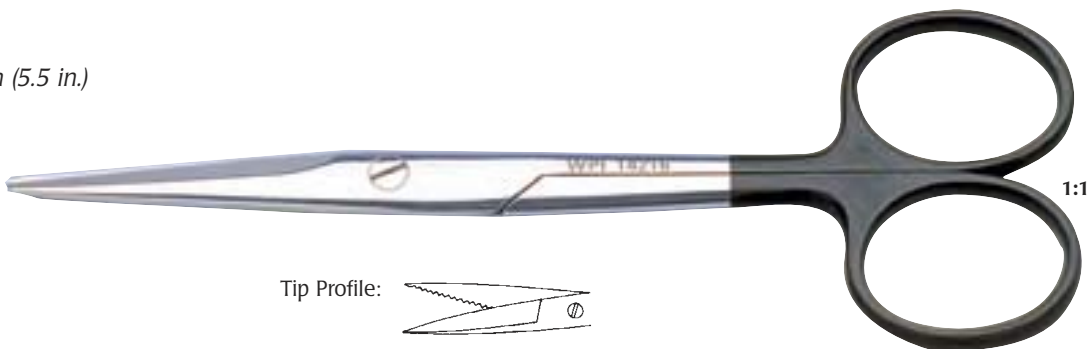

Tip Profile:

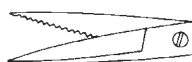

**SuperCut Tungsten Carbide Mayo Scissors**

These are the finest scissors available. They combine the precise cutting action of the razor-sharp SuperCut blades with the durability of **Tungsten Carbide**. They will provide a clean, smooth cut and retain their sharpness for an extended period of time.

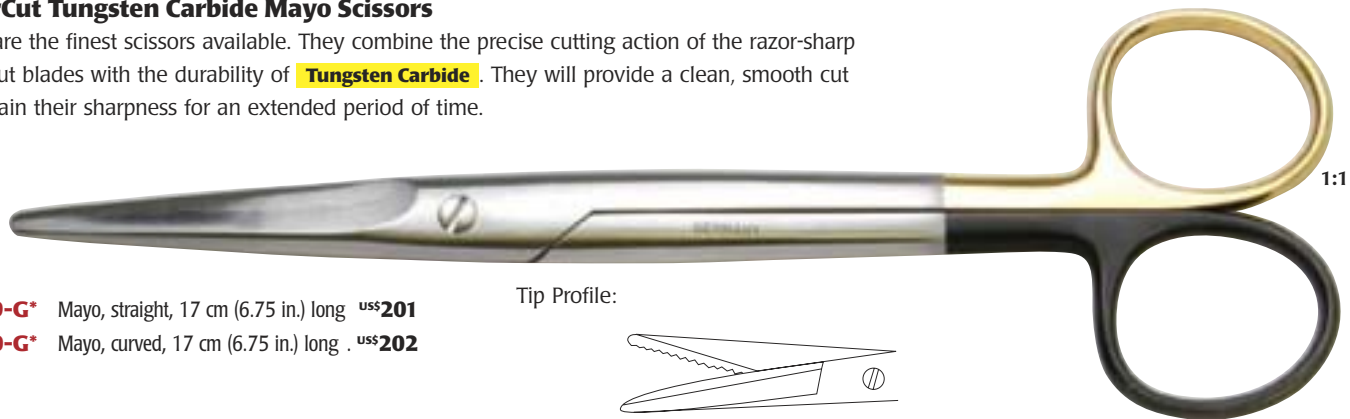

<b>501259-G*</b>	Mayo, straight, 17 cm (6.75 in.) long	US\$201
<b>501260-G*</b>	Mayo, curved, 17 cm (6.75 in.) long	US\$202

Tip Profile:

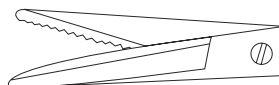

\* Part numbers ending in "-G" indicate German-made instruments

Prices shown are in U.S. dollars. Actual charges will vary because of import duty, freight, and currency fluctuations. To obtain an exact quotation, contact your WPI office.

World Precision Instruments • Tel: 941-371-1003 • Fax: 941-377-5428 • E-mail: sales@wpiinc.com • Internet: www.wpiinc.com

**Operating Scissors**

**11.5 cm (4.5 in.) Straight**

<b>501753</b>	Sharp/Blunt	US\$17	<b>501753-G*</b>	US\$48
<b>501754</b>	Sharp/Sharp	US\$17	<b>501754-G*</b>	US\$48
<b>501743</b>	Blunt/Blunt	US\$17	<b>501743-G*</b>	US\$51

**11.5 cm (4.5 in.) Curved**

<b>501755</b>	Sharp/Sharp	US\$17	<b>501755-G*</b>	US\$51
<b>501756</b>	Sharp/Blunt	US\$17	<b>501756-G*</b>	US\$53
<b>501757</b>	Blunt/Blunt	US\$17	<b>501757-G*</b>	US\$53



**14 cm (5.5 in.) Curved**

<b>501220</b>	Sharp/Sharp	US\$18	<b>501220-G*</b>	US\$33
<b>501221</b>	Sharp/Blunt	US\$18	<b>501221-G*</b>	US\$33
<b>501222</b>	Blunt/Blunt	US\$18	<b>501222-G*</b>	US\$33

**14 cm (5.5 in.) Straight**

<b>14192</b>	Sharp/Blunt	US\$18	<b>14192-G*</b>	US\$33
<b>501218</b>	Sharp/Sharp	US\$18	<b>501218-G*</b>	US\$33
<b>501219</b>	Blunt/Blunt	US\$18	<b>501219-G*</b>	US\$33

Tip Profiles:



Sharp/Blunt



Sharp/Sharp



Blunt/Blunt

**16 cm (6.25 in.) Straight**

<b>501223</b>	Sharp/Blunt	US\$18	<b>501223-G*</b>	US\$33
<b>501224</b>	Blunt/Blunt	US\$18	<b>501224-G*</b>	US\$33
<b>501225</b>	Sharp/Sharp	US\$18	<b>501225-G*</b>	US\$33

**16 cm (6.25 in.) Curved**

<b>501226</b>	Sharp/Blunt	US\$18	<b>501226-G*</b>	US\$33
<b>501227</b>	Blunt/Blunt	US\$18	<b>501227-G*</b>	US\$33
<b>501228</b>	Sharp/Sharp	US\$18	<b>501228-G*</b>	US\$33



**18 cm (7 in.) Straight**

<b>15924</b>	Sharp/Sharp	US\$20	<b>15924-G*</b>	US\$44
<b>500378</b>	Sharp/Blunt	US\$20	<b>500378-G*</b>	US\$44
<b>500379</b>	Blunt/Blunt	US\$20	<b>500379-G*</b>	US\$44

**18 cm (7 in.) Curved**

<b>501229</b>	Sharp/Blunt	US\$20	<b>501229-G*</b>	US\$44
<b>501230</b>	Blunt/Blunt	US\$20	<b>501230-G*</b>	US\$44
<b>501231</b>	Sharp/Sharp	US\$20	<b>501231-G*</b>	US\$44

\* Part numbers ending in "-G" indicate German-made instruments

**Titanium** instruments MRI compatible

Prices shown are in U.S. dollars. Actual charges will vary because of import duty, freight, and currency fluctuations. To obtain an exact quotation, contact your WPI office.

**Eye Scissors, Blunt, Probe Points, 10 cm (4 in.)**

Straight **500366** . . . . . **US\$37**  
**500366-G\*** . . . . . **US\$63**

Curved **500367** . . . . . **US\$37**  
**500367-G\*** . . . . . **US\$66**

Tip Profile:

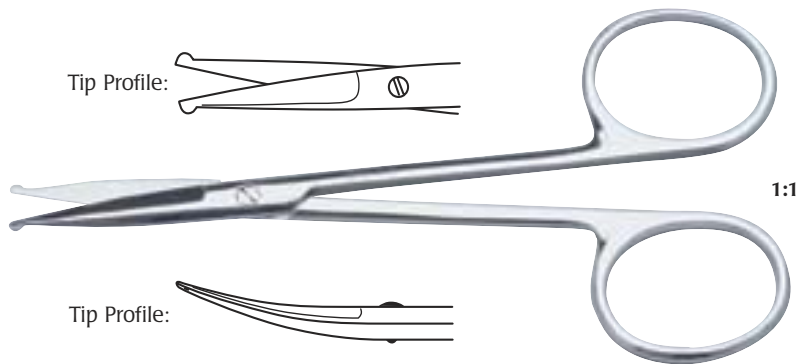

Tip Profile:



**SuperCut Angled Iris Scissors**

10 cm long  
 30° angled to side  
**500046** . . . . . **US\$59**

Tip Profile:

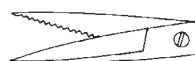

**Angled Scissors**

14 cm long  
 30° angled to side  
 sharp/sharp tips  
**500047** . . . . . **US\$16**  
**500047-G\*** . . . . . **US\$54**



**Ligature scissors**

<b>500380</b>	9 cm (3.5 in.) long . . . . .	<b>US\$25</b>	<b>500380-G*</b> . . . . .	<b>US\$48</b>
<b>501703</b>	10.75 cm (4.25 in.) long . . . . .	<b>US\$26</b>	<b>501703-G*</b> . . . . .	<b>US\$48</b>
<b>501704</b>	13.25 cm (5.25 in.) long . . . . .	<b>US\$28</b>	<b>501704-G*</b> . . . . .	<b>US\$48</b>



**Lister Bandage scissors**

<b>500444</b>	15 cm (6 in.) long, 4cm long blades . . . . .	<b>US\$25</b>	<b>500444-G*</b> . . . . .	<b>US\$44</b>
<b>501701</b>	8.75 cm (3.5 in.) long . . . . .	<b>US\$16</b>	<b>501701-G*</b> . . . . .	<b>US\$35</b>
<b>501702</b>	10.75 cm (4.25 in.) long . . . . .	<b>US\$17</b>	<b>501702-G*</b> . . . . .	<b>US\$37</b>
<b>555656S</b>	Bandage scissors . . . . .	<b>US\$138</b>	<b>Titanium</b>	

\* Part numbers ending in "-G" indicate German-made instruments

Prices shown are in U.S. dollars. Actual charges will vary because of import duty, freight, and currency fluctuations. To obtain an exact quotation, contact your WPI office.